

ITEM NO.	DESCRIPTION	MATERIAL	COLOR	QTY
1	Front panel	Al-profile	Black	1
2	Side panel	Al-profile	Black	2
3	Back panel	Al-profile	Black	1
4	Cover angel	Al-profile	Clear	2
5	Top/Bottom plate	Steel/Dobel	Black	2
6	Handle	Al-profile	Clear	2

Top view

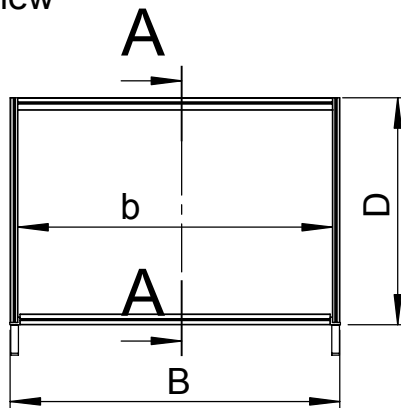

Side view

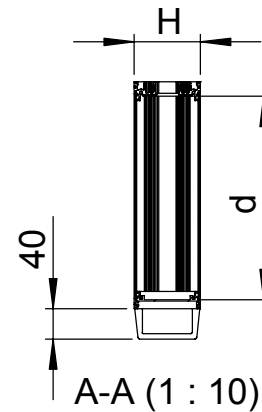

MODEL	B [mm]	H [mm]	D [mm]	b [mm]	d [mm]
MAXI 2-75	250	87.5	300	230	269
MAXI 2-130	436	87.5	300	416	269
MAXI 2-170	436	87.5	400	416	369
MAXI 3-75	250	132.5	300	230	269
MAXI 3-130	436	132.5	300	416	269
MAXI 3-170	436	132.5	400	416	369

Side panel(broken out view) MAXI 3-all

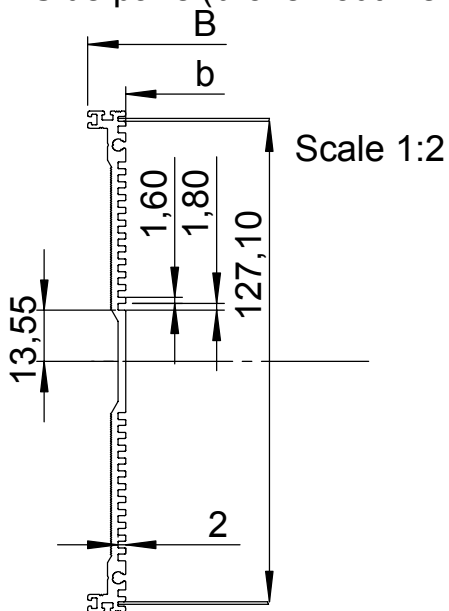

Side panel(broken out view) MAXI 2-all

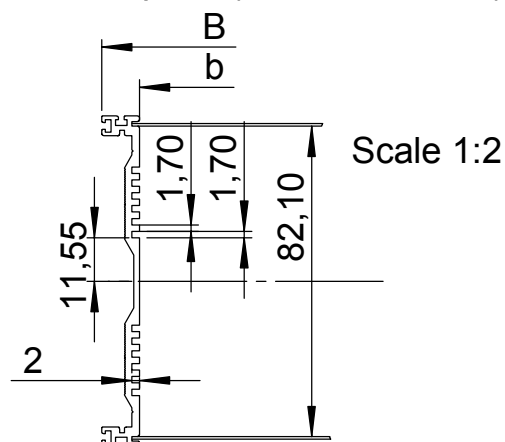

**FlexiBox**

Skala/Scale  
1:10

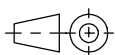

Benämning/Denomination

Data sheet, MAXI

Ritn nr/Drawing No

SD000 026 192

## Front panel

MODEL	B [mm]	H [mm]	h [mm]
MAXI 2-75	224	87.5	77.5
MAXI 2-130	410	87.5	77.5
MAXI 2-170	410	87.5	77.5
MAXI 3-75	224	132.5	122.5
MAXI 3-130	410	132.5	122.5
MAXI 3-170	410	132.5	122.5

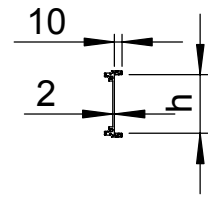
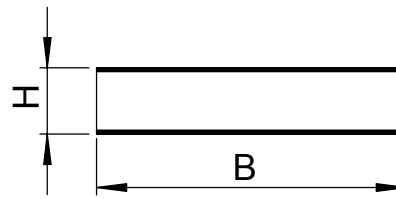

## Back panel

MODEL	B [mm]	H [mm]
MAXI 2-75	230	87.5
MAXI 2-130	416	87.5
MAXI 2-170	416	87.5
MAXI 3-75	230	132.5
MAXI 3-130	416	132.5
MAXI 3-170	416	132.5

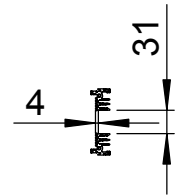
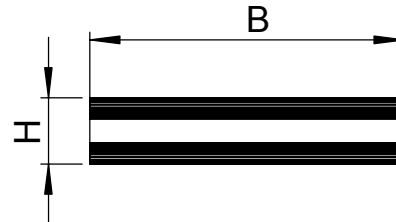

**FlexiBox**

Skala/Scale  
1:10

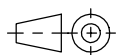

Benämning/Denomination

Data sheet, MAXI

Ritn nr/Drawing No

SD000 026 192